

EBMHS-SR | Sensor Ready (SR), miniature, ceiling, luminaire mounted, PIR, presence detector



Key Product Features:

- SR™ certified by Philips
- Small and unobtrusive design
- Infrared programmable using our IR handsets
- Mounting heights up to 9m
- A selection of fixing clips to allow the unit to be mounted in or to the side of a luminaire are available
- 5 year warranty

Dimensions (mm)

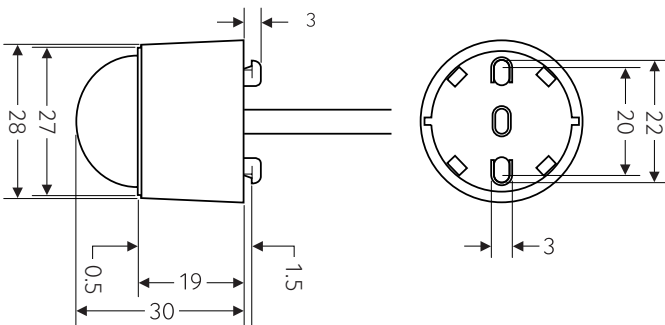

Detection pattern

high < sensitivity > low

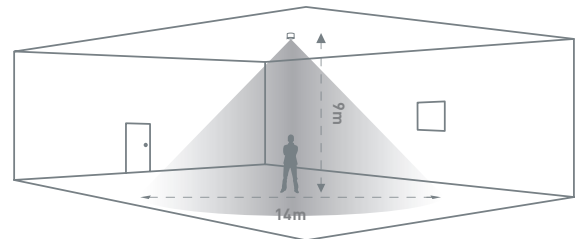

Walk across



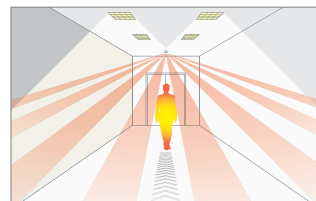

Height	Range Diameter
9m	14m
7m	13m
5m	11m
3m	8m

Walk towards















Height	Range Diameter
9m	7m
7m	7m
5m	7m
3m	5m

Technical Data

Part Code	EBMHS-SR
Weight	0.1kg
Supply voltage DC	9.5–22.5 VDC over DALI
Working temperature range	-10 to 35°C
Humidity	5 to 95% non-condensing
Material (casing)	Flame retardant ABS
IP rating	40
Compliance	 EMC-2014/30/EU  UL LISTED UL 773A, 6th Ed. CSA C22.2 NO. 284, 1st Ed. category: Photoelectric switches

Accessories and Associated Products

Part Number	Description
 UHS5	Compact, programming/ commissioning handset
 UHS7	Compact, user handset
 UNLCDHS	Professional, programming/ commissioning LCD handset
 EBMPIR-FRW	Head flush ring
 EBMPIR-ECW	Head end cap

 <p>www.cpelectronics.co.uk</p>	<p>CP Electronics A Business unit of Legrand Electric Limited, Brent Crescent, London NW10 7XR, UK t. +44 (0)333 900 0671 info@cpelectronics.co.uk</p> <p>connect with us    </p>	<p>Important notice: This device should be installed by a qualified electrician in accordance with the latest edition of the IEE Wiring Regulations and the applicable Building Regulations.</p> <p>Due to our policy of continual product improvement CP Electronics reserves the right to alter the specification of this product without prior notice.</p> <div style="text-align: right;">   </div>
--	---	---